

SVENBOX

OFFICE SOLUTIONS

cennik v.3

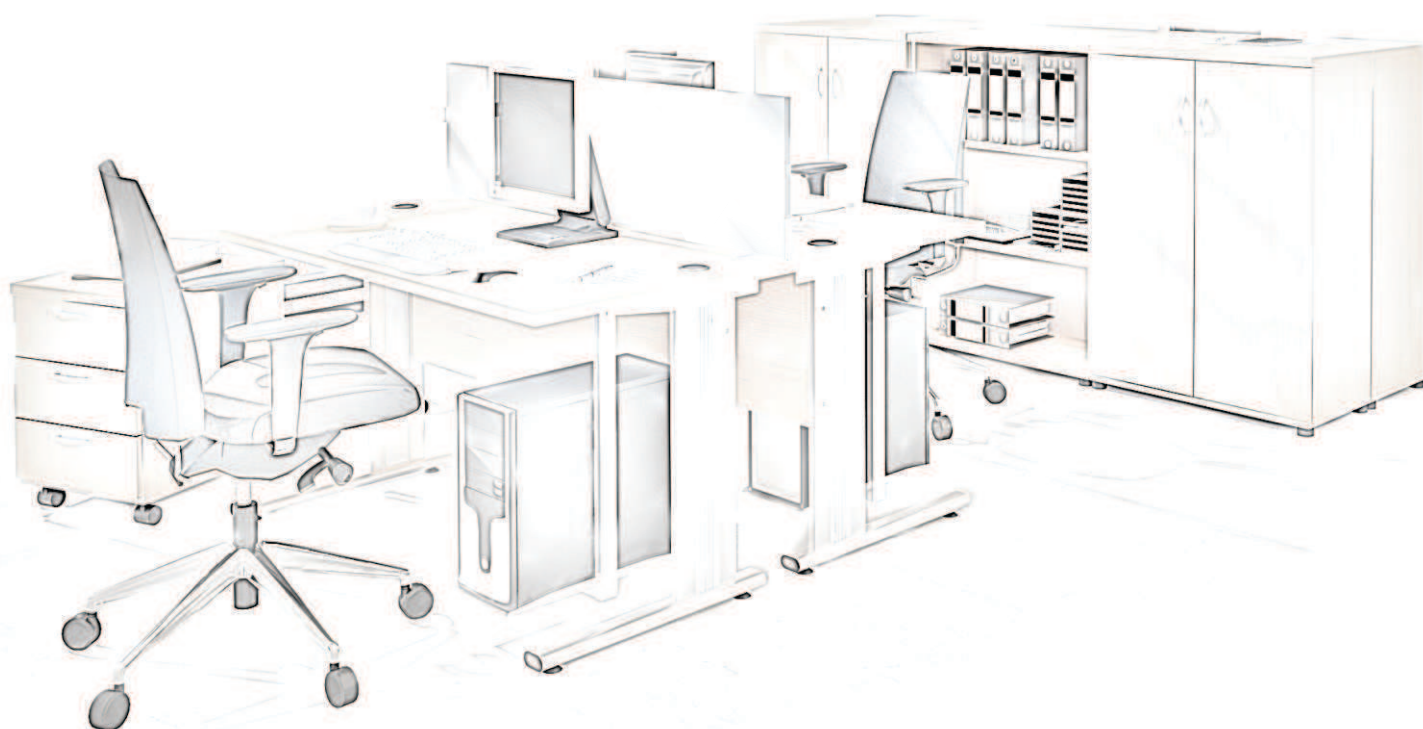

► SVENBOX CLASSIC

ELEMENTY PŁYTOWE

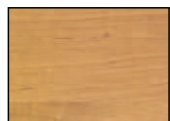

28 - OLCHA



29 - CALVADOS

BIURKA / PRZYSTAWKI
- blat
- osłona płytowa
- nogi płytowe

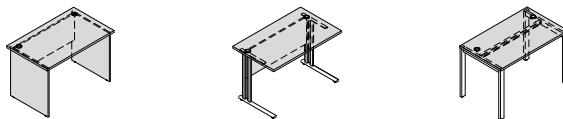

SZAFY / KONTENERY
- wieniec górny
- wieniec dolny
- font płytowy
- korpus

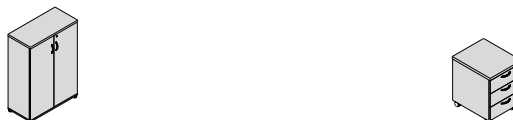

UKŁADY WIELOSTANOWISKOWE / STOŁY KONFERENCYJNE / STOLIKI
- blat
- nogi płytowe
- blenda płytowa

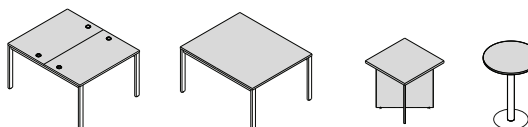

ELEMENTY PŁYTOWE



84 - POPIEL

PANELE PŁYTOWE

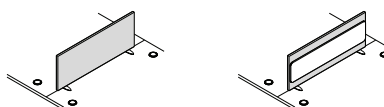

SZAFKA ŻALUZJOWA
- wieniec górny
- wieniec dolny
- korpus

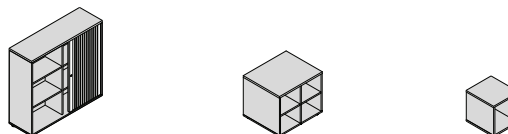

ELEMENTY DODATKOWE

ELEMENTY METALOWE



09 - ALUMINIUM

BIURKA / PRZYSTAWKI
- stelaż metalowy
- noga podpierająca

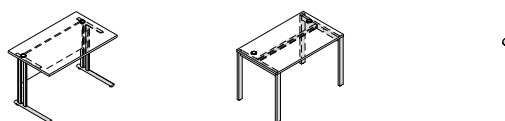

UKŁADY WIELOSTANOWISKOWE / STOŁY KONFERENCYJNE (bez stołu PSC06)
- stelaż metalowy

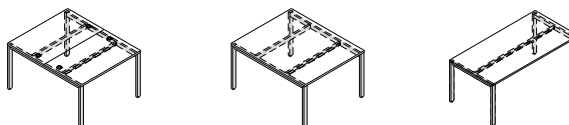

OSŁONA RASTROWA

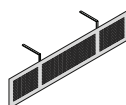

09 - ALUMINIUM



15 - BIAŁY POŁYSK

STELAŻ



ELEMENTY TKANINOWE



NE-3 POMARAŃCZOWY



NE-5 CZERWONY



NE-9 ZIELONY



NE-10 JASNOSZARY



NE-14 CIEMNOSZARY



NE-15 NIEBIESKI



NE-16 CZARNY

PODUSZKA TKANINOWA

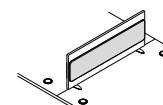

1. BIURKA

1.1 BLAT

plyta melaminowana 28mm, obrzeże PVC 2mm

blat z przelotami kablowymi $\varnothing 60$

biurka proste

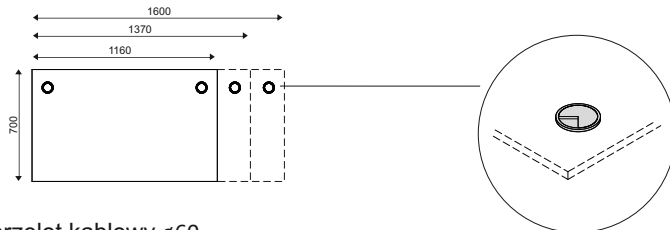

przelot kablowy $\varnothing 60$
kolor: 09 ALUMINIUM

biurka kształtowe

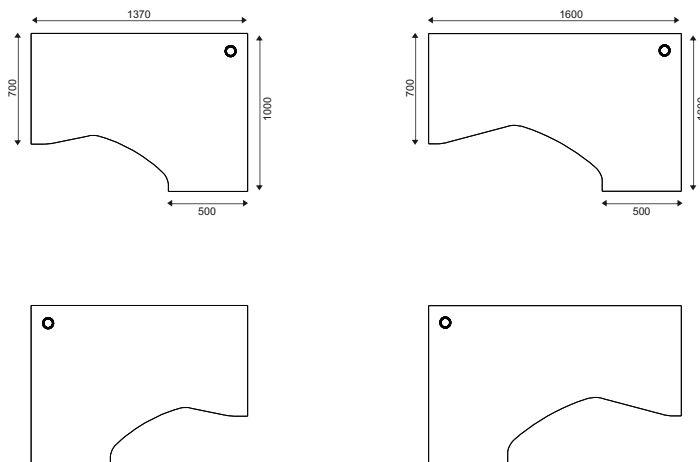

1. BIURKA

1.2 PODSTAWA

EKO_C

nogi płytowe - płyta melaminowana 18mm
blenda - płyta melaminowana 18mm

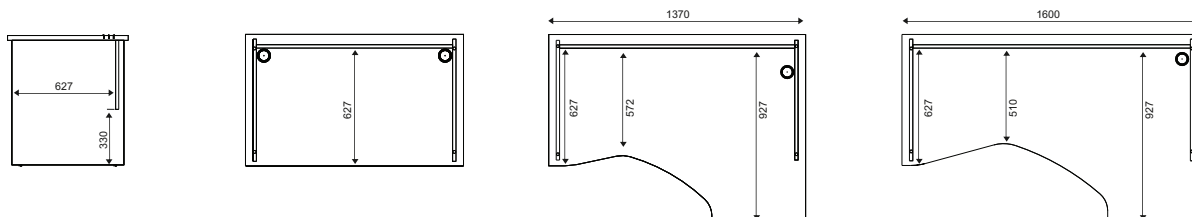
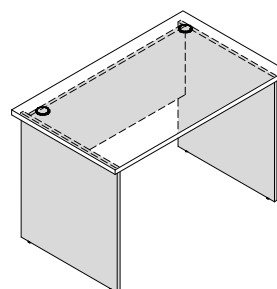

VIK_C

nogi metalowe - metal malowany proszkowo
blenda - płyta melaminowana 18mm

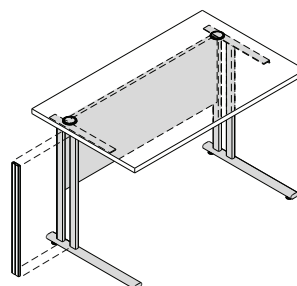

ELEMENT DODATKOWY
 kanał kablowy BM01 (2 szt.)

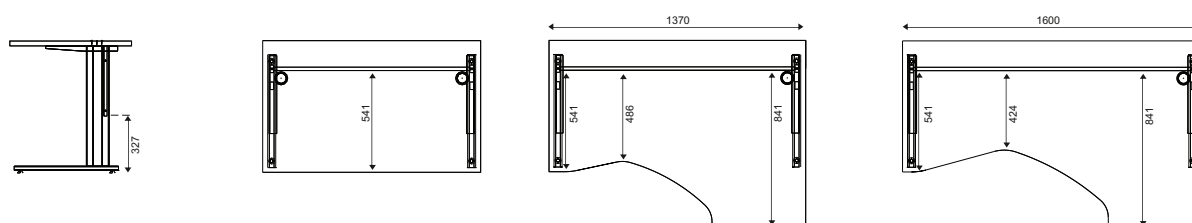

ART_C

stelaż - metal malowany proszkowo
 profil 30x60

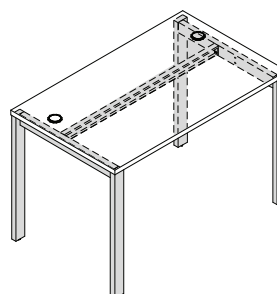

2. UKŁADY WIELOSTANOWISKOWE

2.1 BLAT

plyta melaminowana 28mm, obrzeże PVC 2mm

STANDARD

blat z przelotami kablowymi $\varnothing 60$

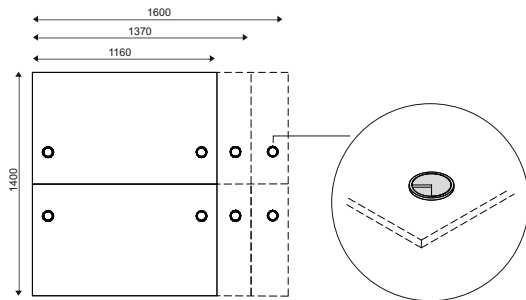

2.2 STELAŻ

metal malowany proszkowo
profil 30x60

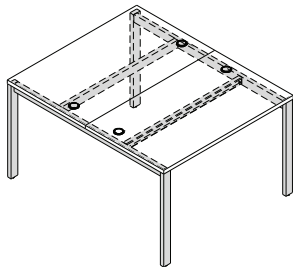

2.3 TWORZENIE UKŁADÓW WIELOSTANOWISKOWYCH

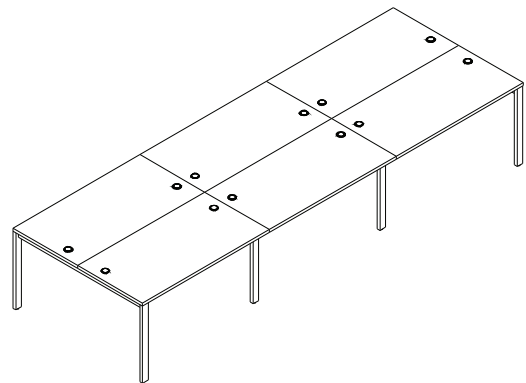
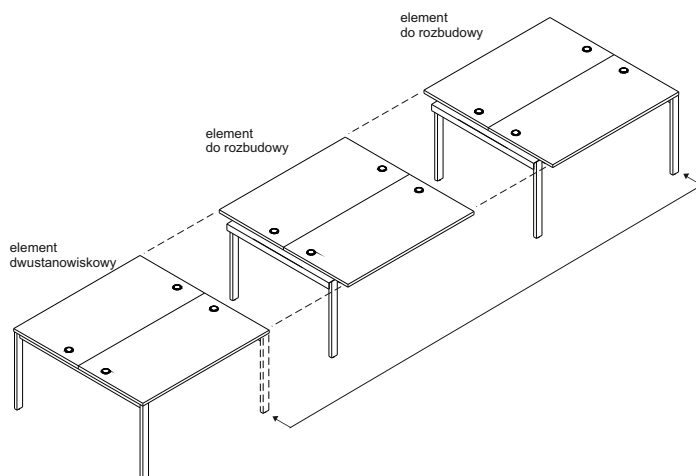

3. STOŁY KONFERENCYJNE

3.1 BLAT

plyta melaminowana 28mm, obrzeże PVC 2mm

STANDARD blat prosty

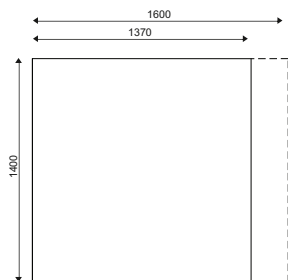

OPCJA blat prosty TOP ACCESS M05

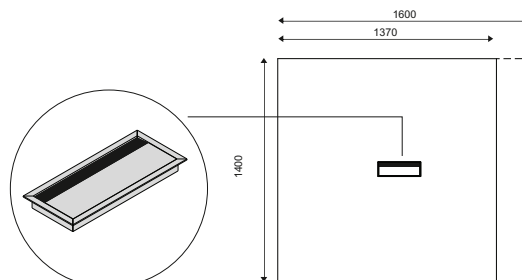

3.2 STELAŻ

metal malowany proszkowo
profil 30x60

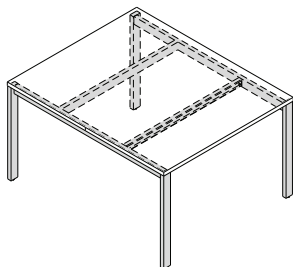

3.3 ROZBUDOWA STOŁU KONFERENCYJNEGO

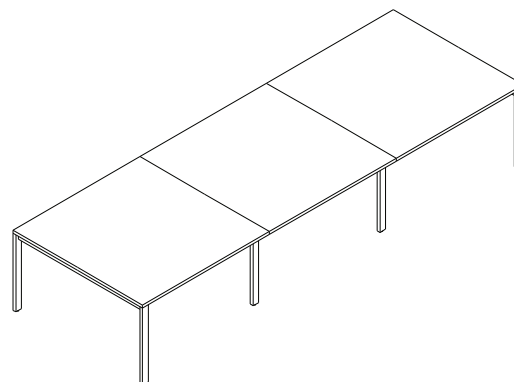
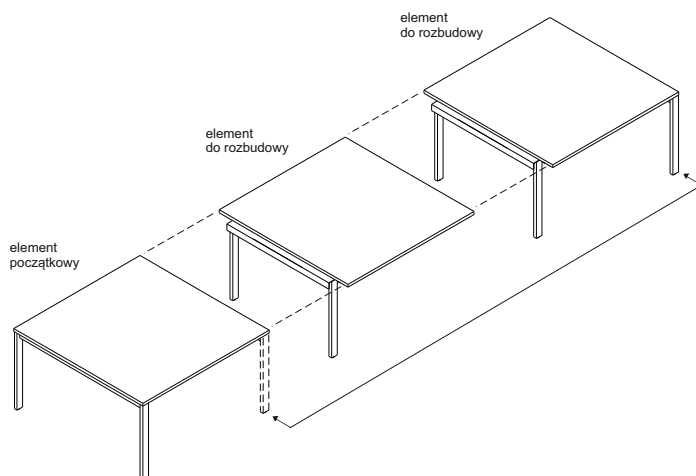

4. PANELE DO UKŁADÓW WIELOSTANOWISKORZYCH

PANELE PŁYTOWE

plyta melaminowana 18mm

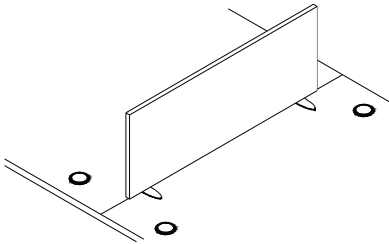
PANELE PŁYTOWE
Z PODUSZKAMI TKANINOWYMI

plyta melaminowana 18mm

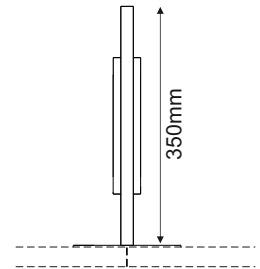
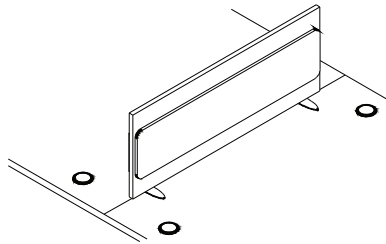

5. PRZYSTAWKI

5.1 BLAT

plyta melaminowana 28mm, obrzeże PVC 2mm

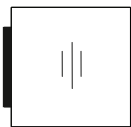

5.2 NOGA PODPIERAJĄCA

metal malowany proszkowo

 profil 40x40 mm

6. STOŁY KONFERENCYJNE

6.1 BLAT

plyta melaminowana 28mm, obrzeże PVC 2mm

6.1 STELAŻ

PSC07 stół składany

stelaż - chrom

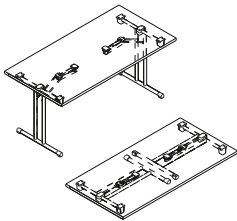
**CST08**

blat - ø800

talerz - stal nierdzewna, ø500

kolumna - metal malowany proszkowo, ø60

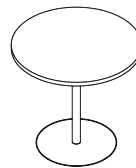
**PH62 PH64**

podstawa - płyta melaminowana 18mm

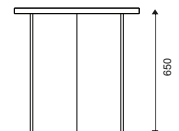
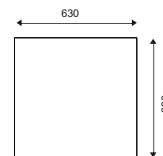
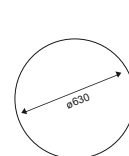
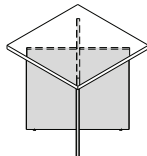
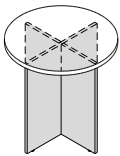
**PH53**

podstawa - płyta melaminowana 18mm

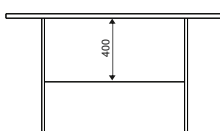
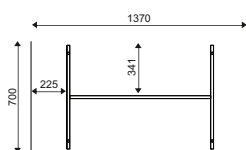
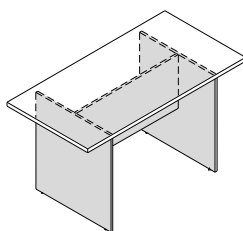
**PH55**

stelaż - metal malowany proszkowo
profil - 30x60 mm

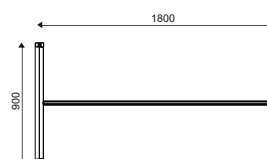
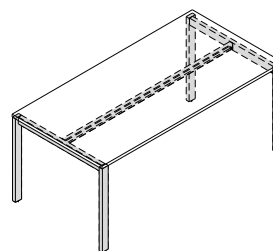

7. SZAFY I REGAŁY

7.1 WIENIEC GÓRNY

plyta melaminowana 28mm, obrzeże PVC 2mm

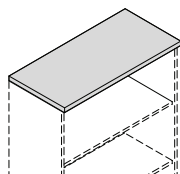

7.2 KORPUS

plyta melaminowana 18mm

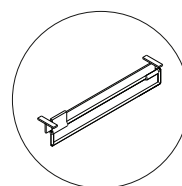
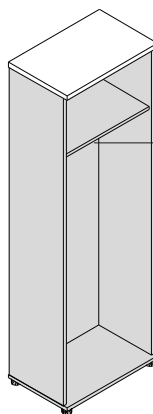
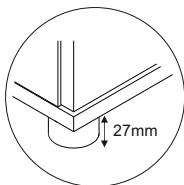
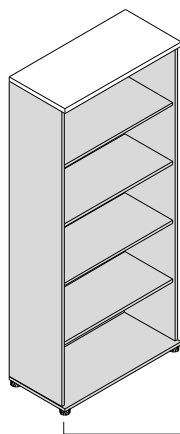

wieszak wysuwny
chromowany

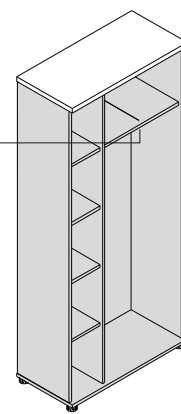

H62
szafa ubraniowa bez zamka

H52
szafa ubraniowo-aktowa
bez zamka

7.3 FRONT DO SZAF I REGAŁÓW

drzwi płytowe
- płyta melaminowana 18mm
- zamek patentowy

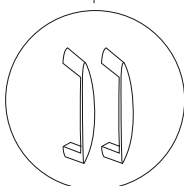
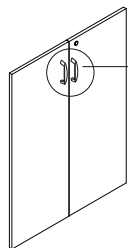

drzwi szklane(2szt.) 3OH,
- szkło hartowane bezbarwne
- bez zamka

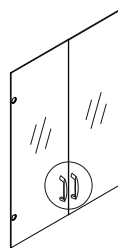

drzwi szklane(2szt.) 3OH
- ramka aluminiowa
- szkło hartowane mleczne
- bez zamka

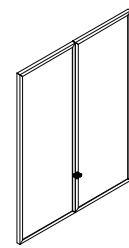

8. SZAFKA ŻALUZYJOWA

WIENIEC GÓRNY

plyta melaminowana 28mm,
obrzeże PVC 2mm

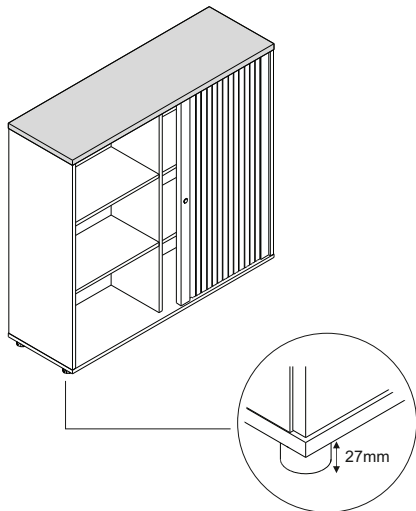

KORPUS

plyta melaminowana 18mm,
obrzeże PVC 2mm

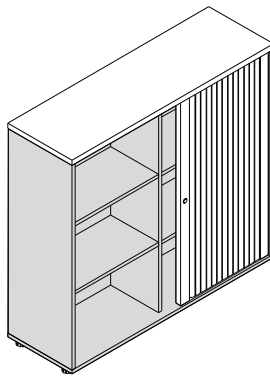

FRONT

żaluzja 09 - aluminium

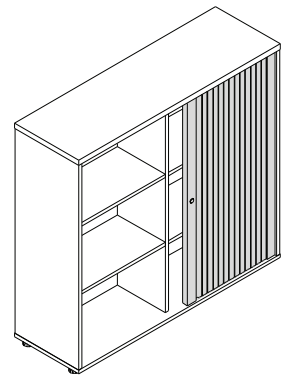

9. KONTENERY

KH13

WIENIEC GÓRNY

plyta melaminowana 28mm,
obrzeże PVC 2mm

KORPUS

plyta melaminowana 18mm

FRONT

plyta melaminowana 18mm
zamek centralny

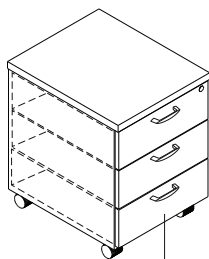

KH23

KORPUS

plyta melaminowana 18mm

FRONT

plyta melaminowana 18mm
uniwersalny L/P bez zamka

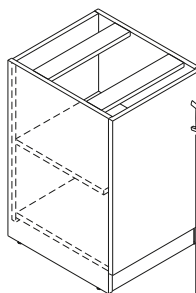

KH26



KORPUS

plyta melaminowana 18mm

FRONT

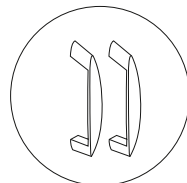
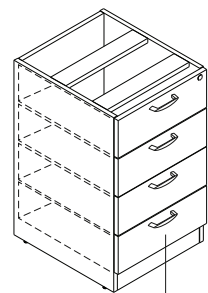
plyta melaminowana 18mm
zamek centralny



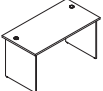
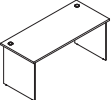

| WIDOK i RZUT OBIEKTU | WYMIARY [mm] | | | SYMBOL | CENA NETTO PLN |  |  |  | UWAGI |
|----------------------|--------------|-----------|----------|--------|----------------|---|---|---|-------|
| | SZEROKOŚĆ | GLĘBOKOŚĆ | WYSOKOŚĆ | | | kg | m3 | szt | |

BIURKA PROSTE

| | | | | | | | | | |
|---|------|-----|-----|--------------|-------|------|-------|---|--|
|  | 1160 | 700 | 758 | BH071 | 250,- | 29.7 | 0.073 | 3 | |
|  | 1370 | 700 | 758 | BH073 | 275,- | 32.9 | 0.081 | 3 | |
|  | 1600 | 700 | 758 | BH076 | 295,- | 37.2 | 0.088 | 3 | |

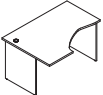
BIURKA KSZTAŁTOWE

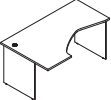

| | | | | | | | | | |
|---|------|------|-----|--------------|-------|------|-------|---|--|
|  | 1370 | 1000 | 758 | BH025 | 395,- | 35.8 | 0.102 | 3 | |
|  | 1370 | 1000 | 758 | BH026 | 395,- | 36.4 | 0.109 | 3 | |
|  | 1600 | 1000 | 758 | BH047 | 430,- | 42.0 | 0.113 | 3 | |
|  | 1600 | 1000 | 758 | BH048 | 430,- | 42.3 | 0.113 | 3 | |

LEGENDA:

 - WAGA NETTO

 - OBJĘTOŚĆ



 - ILOŚĆ PACZEK

| WIDOK i RZUT OBIEKTU | WYMIARY [mm] | | | SYMBOL | CENA NETTO PLN |  |  |  | UWAGI |
|----------------------|--------------|-----------|----------|--------|----------------|---|---|---|-------|
| | SZEROKOŚĆ | GLĘBOKOŚĆ | WYSOKOŚĆ | | | kg | m3 | szt | |

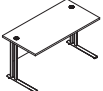
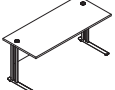
BIURKA PROSTE

| | | | | | | | | | |
|---|------|-----|-----|--------------|-------|------|-------|---|--|
|  | 1160 | 700 | 758 | BM071 | 335,- | 27.7 | 0.081 | 3 | |
|  | 1370 | 700 | 758 | BM073 | 365,- | 30.9 | 0.088 | 3 | |
|  | 1600 | 700 | 758 | BM076 | 390,- | 35.1 | 0.096 | 3 | |

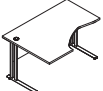
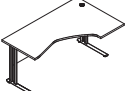
BIURKA KSZTAŁTOWE

| | | | | | | | | | |
|---|------|------|-----|--------------|-------|------|-------|---|--|
|  | 1370 | 1000 | 758 | BM025 | 490,- | 33.7 | 0.109 | 3 | |
|  | 1370 | 1000 | 758 | BM026 | 490,- | 34.4 | 0.116 | 3 | |
|  | 1600 | 1000 | 758 | BM047 | 510,- | 39.9 | 0.121 | 3 | |
|  | 1600 | 1000 | 758 | BM048 | 510,- | 40.3 | 0.121 | 3 | |

AKCESORIA

| | | | | | | | | | |
|---|-----|----|----|-------------|------|-----|-------|---|--------------------------|
|  | 682 | 50 | 30 | BM01 | 40,- | 0.5 | 0.004 | 1 | kanal kablowy KPL (2szt) |
|---|-----|----|----|-------------|------|-----|-------|---|--------------------------|

LEGENDA:

 - WAGA NETTO

 - OBJĘTOŚĆ

 - ILOŚĆ PACZEK

| WIDOK i RZUT OBIEKTU | WYMIARY [mm] | | | SYMBOL | CENA NETTO PLN | | | | | UWAGI |
|----------------------|--------------|-----------|----------|--------|----------------|----|----|-----|--|-------|
| | SZEROKOŚĆ | GLĘBOKOŚĆ | WYSOKOŚĆ | | | kg | m3 | szt | | |

BIURKA PROSTE

| | | | | | | | | | | |
|--|------|-----|-----|--------------|-------|------|-------|---|--|--|
| | 1160 | 700 | 758 | BSA71 | 400,- | 32.2 | 0.077 | 3 | | |
| | 1370 | 700 | 758 | BSA73 | 420,- | 35.8 | 0.084 | 3 | | |
| | 1600 | 700 | 758 | BSA76 | 440,- | 39.8 | 0.091 | 3 | | |

BIURKA KSZTAŁTOWE

| | | | | | | | | | | |
|--|------|------|-----|--------------|-------|------|-------|---|--|--|
| | 1370 | 1000 | 758 | BSA25 | 540,- | 39.5 | 0.100 | 3 | | |
| | 1370 | 1000 | 758 | BSA26 | 540,- | 39.5 | 0.100 | 3 | | |
| | 1600 | 1000 | 758 | BSA47 | 560,- | 42.7 | 0.110 | 3 | | |
| | 1600 | 1000 | 758 | BSA48 | 560,- | 42.7 | 0.110 | 3 | | |

ELEMENTY DO TWORZENIA UKŁADÓW BIUREK



| | | | | | | | | | | |
|--|------|-----|-----|--------------|-------|------|-------|---|--|--|
| | 1160 | 700 | 758 | BSA12 | 350,- | 35.4 | 0.071 | 3 | | |
| | 1370 | 700 | 758 | BSA14 | 370,- | 39.0 | 0.078 | 3 | | |
| | 1600 | 700 | 758 | BSA16 | 390,- | 43.0 | 0.085 | 3 | | |

LEGENDA:

- WAGA NETTO

- OBJĘTOŚĆ

- ILOŚĆ PACZEK

| WIDOK i RZUT OBIEKTU | WYMIARY [mm] | | | SYMBOL | CENA NETTO PLN |  |  |  | UWAGI |
|----------------------|--------------|-----------|----------|--------|----------------|---|---|---|-------|
| | SZEROKOŚĆ | GLĘBOKOŚĆ | WYSOKOŚĆ | | | kg | m3 | szt | |

UKŁADY WIELOSTANOWISKOWE

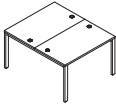
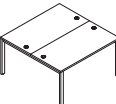
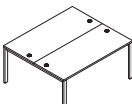
| | | | | | | | | | |
|---|------|------|-----|--------------|-------|------|-------|---|-----------------------|
|  | 1160 | 1400 | 758 | BSA21 | 800,- | 55.6 | 0.153 | 5 | układ dwustanowiskowy |
|  | 1370 | 1400 | 758 | BSA23 | 840,- | 62.8 | 0.165 | 5 | układ dwustanowiskowy |
|  | 1600 | 1400 | 758 | BSA24 | 880,- | 70.8 | 0.179 | 5 | układ dwustanowiskowy |

ELEMENTY DO TWORZENIA UKŁADÓW BIUREK

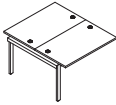
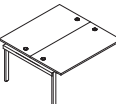
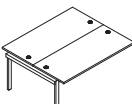

| | | | | | | | | | |
|---|------|------|-----|---------------|-------|------|-------|---|--|
|  | 1160 | 1400 | 758 | BSA211 | 700,- | 48.5 | 0.143 | 5 | |
|  | 1370 | 1400 | 758 | BSA213 | 800,- | 55.7 | 0.155 | 5 | |
|  | 1600 | 1400 | 758 | BSA214 | 840,- | 63.7 | 0.169 | 5 | |

LEGENDA:

 - WAGA NETTO

 - OBJĘTOŚĆ



 - ILOŚĆ PACZEK

| WIDOK i RZUT OBIEKTU | WYMIARY [mm] | | | SYMBOL | CENA NETTO PLN |  |  |  | UWAGI |
|----------------------|--------------|-----------|----------|--------|----------------|---|---|---|-------|
| | SZEROKOŚĆ | GLĘBOKOŚĆ | WYSOKOŚĆ | | | kg | m3 | szt | |

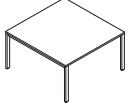
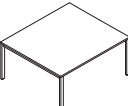
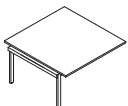
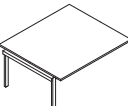
STOŁY KONFERENCYJNE

| | | | | | | | | | |
|---|------|------|-----|---------------|-------|-------|-------|---|------------------------------|
|  | 1370 | 1400 | 758 | BSA123 | 820,- | 92.4 | 0.319 | 7 | |
|  | 1600 | 1400 | 758 | BSA124 | 860,- | 104.4 | 0.343 | 7 | |
|  | 1370 | 1400 | 758 | BSA113 | 780,- | 82.9 | 0.216 | 6 | element do rozbudowy układów |
|  | 1600 | 1400 | 758 | BSA114 | 820,- | 94.9 | 0.240 | 6 | element do rozbudowy układów |

DODATKOWA DOPLATA DO CECHY



| CECHA | SYMBOL | | | | | | | |  |  |  | UWAGI |
|----------------|--------|--------|--------|--------|--|--|--|--|---|---|---|-------|
| | BSA123 | BSA124 | BSA113 | BSA114 | | | | | kg | m3 | szt | |
| TOP ACCESS M05 | 150,- | 150,- | 150,- | 150,- | | | | | 0.9 | 0.0070 | 1 | |

LEGENDA:







 - WAGA NETTO

 - OBJĘTOŚĆ

 - ILOŚĆ PACZEK

| WIDOK I RZUT OBIEKTU | WYMIARY [mm] | | | SYMBOL | CENA NETTO PLN |  |  |  | UWAGI |
|----------------------|--------------|-----------|----------|--------|----------------|---|---|---|-------|
| | SZEROKOŚĆ | GLEBOKOŚĆ | WYSOKOŚĆ | | | kg | m3 | szt | |

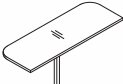
PRZYSTAWKI DO BIUREK

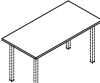
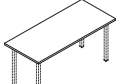
| | | | | | | | | | |
|---|------|------|-----|-------------|-------|------|-------|---|--|
|  | 700 | 700 | 28 | PH77 | 130,- | 12.5 | 0.018 | 1 | |
|  | 500 | 500 | 28 | TH10 | 60,- | 5.3 | 0.011 | 1 | |
|  | 500 | 700 | 28 | TH09 | 70,- | 7.3 | 0.015 | 1 | |
|  | 500 | 900 | 28 | TH11 | 85,- | 8.5 | 0.018 | 1 | |
|  | 500 | 1400 | 758 | PH71 | 220,- | 14.0 | 0.043 | 2 | |
|  | 400 | 700 | 758 | PH72 | 140,- | 7.7 | 0.029 | 2 | |
|  | 700 | 700 | 28 | TH12 | 75,- | 9.0 | 0.019 | 1 | w cenę nie wliczono nóg podpierających (4szt.) |
|  | 1370 | 700 | 28 | TH15 | 120,- | 17.2 | 0.038 | 1 | w cenę nie wliczono nóg podpierających (4szt.) |
|  | 1600 | 700 | 28 | TH14 | 130,- | 22.0 | 0.041 | 1 | w cenę nie wliczono nóg podpierających (4szt.) |

NOGI PODPIERAJĄCE

| | | | | | | | | | |
|---|----|----|-----|-------------|------|-----|-------|---|-----------------|
|  | 40 | 40 | 730 | NH44 | 65,- | 2.0 | 0.017 | 1 | noga kwadratowa |
|---|----|----|-----|-------------|------|-----|-------|---|-----------------|

OSŁONY PRZEDNIE DO BIUREK - RASTROWE

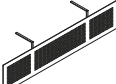

| | | | | | | | | | |
|---|------|----|-----|--------------|-------|-----|-------|---|--|
|  | 1400 | 15 | 300 | CUR15 | 286,- | 3.1 | 0.009 | 1 | |
|---|------|----|-----|--------------|-------|-----|-------|---|--|

LEGENDA:



 - WAGA NETTO

 - OBJĘTOŚĆ



 - ILOŚĆ PACZEK

| WIDOK i RZUT OBIEKTU | WYMIARY [mm] | | | SYMBOL | CENA NETTO PLN |  |  |  | UWAGI |
|----------------------|--------------|-----------|----------|--------|----------------|---|---|---|-------|
| | SZEROKOŚĆ | GLĘBOKOŚĆ | WYSOKOŚĆ | | | kg | m3 | szt | |

PANELE PŁYTOWE

| | | | | | | | | | |
|---|------|----|-----|--------------|-------|-----|-------|---|--|
|  | 650 | 18 | 350 | RH070 | 110,- | 3.0 | 0.016 | 1 | |
|  | 900 | 18 | 350 | RH090 | 145,- | 4.0 | 0.022 | 1 | |
|  | 1300 | 18 | 350 | RH130 | 165,- | 6.8 | 0.041 | 1 | |

PANELE PŁYTOWE Z PODUSZKAMI TKANINOWYMI













| | | | | | | | | | |
|---|------|----|-----|---------------|-------|------|-------|---|--|
|  | 650 | 45 | 350 | RH070P | 350,- | 9.0 | 0.016 | 1 | |
|  | 900 | 45 | 350 | RH090P | 390,- | 12.0 | 0.022 | 1 | |
|  | 1300 | 45 | 350 | RH130P | 435,- | 17.0 | 0.032 | 1 | |

LEGENDA:

 - WAGA NETTO

 - OBJĘTOŚĆ

 - ILOŚĆ PACZEK

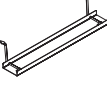

| WIDOK I RZUT OBIEKTU | WYMIARY [mm] | | | SYMBOL | CENA NETTO PLN |  |  |  | UWAGI |
|---|--------------|-----------|----------|--------------|----------------|---|---|---|--|
| | SZEROKOŚĆ | GLĘBOKOŚĆ | WYSOKOŚĆ | | | kg | m3 | szt | |
|  | 140 | 70 | 750 | S81SI | 125,- | 1.1 | 0.008 | 1 | |
|  | 1000 | 70 | 35 | S82SI | 65,- | 1.0 | 0.005 | 1 | |
|  | 212 | 460 | 617 | S83SI | 130,- | 2.7 | 0.027 | 1 | kolor: 09 - aluminium |
|  | | | | AK3SI | 30,- | 0.2 | 0.000 | 1 | |
|  | 470 | 220 | 148 | S73SI | 140,- | 3.2 | 0.002 | 1 | kolor: 84 - popiel |
|  | 470 | 256 | 146 | CH11 | 80,- | 2.5 | 0.012 | 1 | kolor: 84 - popiel |
|  | 362 | 167 | 23 | CH21 | 30,- | 0.5 | 0.003 | 1 | piórnik nakładany, czarny |
|  | 610 | 400 | 85 | C01SI | 125,- | 0.5 | 0.010 | 1 | półka pod klawiaturę - tworzywo szare |
|  | 560 | 372 | 110 | CH01 | 80,- | 4.9 | 0.028 | 1 | półka pod klawiaturę, kolor: 84 - popiel |
|  | 580 | 162 | 123 | S69SI | 75,- | 1.0 | 0.015 | 1 | kolor: 09 - aluminium |
|  | 460 | 110 | 121 | E64SI | 65,- | 0.0 | 0.000 | 0 | |

LEGENDA:





 - WAGA NETTO

 - OBJĘTOŚĆ

 - ILOŚĆ PACZEK

| WIDOK I RZUT OBIEKTU | WYMIARY [mm] | | | SYMBOL | CENA NETTO PLN |  |  |  | UWAGI |
|----------------------|--------------|-----------|----------|--------|----------------|---|---|---|-------|
| | SZEROKOŚĆ | GLĘBOKOŚĆ | WYSOKOŚĆ | | | kg | m3 | szt | |

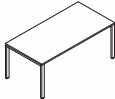
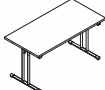
STOŁY I STOLIKI

| | | | | | | | | | |
|---|------|-----|-----|--------------|-------|------|-------|---|--|
|  | 630 | 630 | 650 | PH62 | 225,- | 15.0 | 0.035 | 1 | |
|  | 630 | 630 | 650 | PH64 | 215,- | 17.0 | 0.037 | 1 | |
|  | 1370 | 700 | 758 | PH53 | 285,- | 31.6 | 0.073 | 1 | |
|  | 1800 | 900 | 755 | PH55 | 580,- | 48.0 | 0.108 | 3 | |
|  | 1390 | 695 | 725 | PSC07 | 590,- | 23.0 | 0.112 | 2 | stół składany - stelaż w kolorze chrom |
|  | 800 | 800 | 730 | CST08 | 790,- | 21.0 | 0.218 | 2 | |



LEGENDA:

 - WAGA NETTO

 - OBJĘTOŚĆ

 - ILOŚĆ PACZEK



| WIDOK I RZUT OBIEKTU | WYMIARY [mm] | | | SYMBOL | CENA NETTO PLN | | | | | UWAGI |
|----------------------|--------------|-----------|----------|--------|----------------|----|----|-----|--|-------|
| | SZEROKOŚĆ | GLĘBOKOŚĆ | WYSOKOŚĆ | | | kg | m3 | szt | | |

SZAFY I REGAŁY



| | | | | | | | | | | |
|--|-----|-----|------|-----|-------|------|-------|---|--|-----------------------------------|
| | 802 | 385 | 2185 | H61 | 620,- | 67.4 | 0.137 | 3 | | |
| | 602 | 385 | 1833 | H62 | 410,- | 41.0 | 0.132 | 3 | | szafa ubraniowa bez zamka |
| | 602 | 385 | 1833 | H65 | 295,- | 32.9 | 0.095 | 2 | | |
| | 802 | 802 | 1833 | H05 | 620,- | 68.0 | 0.213 | 2 | | |
| | 802 | 385 | 1833 | H51 | 490,- | 56.6 | 0.137 | 3 | | |
| | 802 | 385 | 1833 | H52 | 580,- | 56.1 | 0.133 | 3 | | szafa ubraniowo-aktowa, bez zamka |
| | 802 | 385 | 1833 | H54 | 420,- | 47.0 | 0.116 | 3 | | |
| | 802 | 385 | 1833 | H55 | 330,- | 40.1 | 0.096 | 2 | | |
| | 802 | 385 | 1129 | H31 | 380,- | 36.6 | 0.088 | 3 | | |
| | 802 | 385 | 1129 | H34 | 340,- | 31.8 | 0.083 | 3 | | |
| | 802 | 385 | 1129 | H35 | 240,- | 24.9 | 0.063 | 2 | | |

LEGENDA:



- WAGA NETTO

- OBJĘTOŚĆ

- ILOŚĆ PACZEK

| WIDOK i RZUT OBIEKTU | WYMIARY [mm] | | | SYMBOL | CENA NETTO PLN |  |  |  | UWAGI |
|----------------------|--------------|-----------|----------|--------|----------------|---|---|---|-------|
| | SZEROKOŚĆ | GLĘBOKOŚĆ | WYSOKOŚĆ | | | kg | m3 | szt | |



SZAFY UNIWERSALNE

| | | | | | | | | | |
|---|-----|-----|-----|------------|-------|------|-------|---|---|
|  | 802 | 385 | 777 | H11 | 320,- | 25.9 | 0.065 | 3 | do zastosowania jako nadstawka, dostawka do biurka lub szafa wolnostojąca |
|  | 802 | 385 | 777 | H12 | 210,- | 19.0 | 0.044 | 2 | do zastosowania jako nadstawka, dostawka do biurka lub szafa wolnostojąca |
|  | 602 | 385 | 777 | H10 | 195,- | 17.6 | 0.045 | 2 | do zastosowania jako nadstawka, dostawka do biurka lub szafa wolnostojąca |



SZAFĄ ŻALUZYJOWĄ

| | | | | | | | | | |
|---|------|-----|------|---------------|---------|------|-------|---|---------------------------|
|  | 1200 | 385 | 1129 | SK3Z06 | 1 250,- | 64.0 | 0.600 | 1 | cała w kolorze 84- popiel |
|---|------|-----|------|---------------|---------|------|-------|---|---------------------------|

ELEMENTY DODATKOWE

| | | | | | | | | | |
|---|-----|-----|-----|--------------|-------|------|-------|---|--|
|  | 710 | 600 | 600 | S85SI | 290,- | 32.0 | 0.066 | 1 | szafka pod ksero, cała w kolorze 84-popiel |
|  | 350 | 385 | 370 | SH351 | 120,- | 6.0 | 0.016 | 1 | organizer - cały w kolorze 84-popiel |

KONTENERY

| | | | | | | | | | |
|---|-----|-----|-----|-------------|-------|------|-------|---|--|
|  | 435 | 525 | 590 | KH13 | 370,- | 24.9 | 0.114 | 1 | |
|  | 428 | 495 | 730 | KH23 | 230,- | 19.3 | 0.044 | 1 | |
|  | 428 | 495 | 730 | KH26 | 420,- | 24.3 | 0.180 | 1 | |

LEGENDA:

 - WAGA NETTO

 - OBJĘTOŚĆ

 - ILOŚĆ PACZEK



| WIDOK i RZUT OBIEKTU | WYMIARY [mm] | | | SYMBOL | CENA NETTO PLN | | | | | UWAGI |
|----------------------|--------------|-----------|----------|--------|----------------|----|----|-----|--|-------|
| | SZEROKOŚĆ | GLĘBOKOŚĆ | WYSOKOŚĆ | | | kg | m3 | szt | | |

ELEMENTY DODATKOWE DO SZAF

| | | | | | | | | | | |
|--|-----|-----|------|--------------|-------|------|-------|---|--|---|
| | 796 | 18 | 1754 | H51D | 175,- | 16.5 | 0.042 | 1 | | |
| | 596 | 18 | 1754 | H62D | 125,- | 14.3 | 0.059 | 1 | | drzwi uniwersalne(lewe i prawe) bez zamka |
| | 796 | 18 | 1050 | H31D | 150,- | 11.8 | 0.025 | 1 | | |
| | 796 | 18 | 699 | H11D | 125,- | 6.9 | 0.020 | 1 | | |
| | 596 | 18 | 699 | H10D | 100,- | 5.0 | 0.026 | 1 | | drzwi uniwersalne(lewe i prawe) bez zamka |
| | 796 | 5 | 1050 | HS23 | 230,- | 11.0 | 0.040 | 1 | | drzwi szklane(2szt.)3OH, szkło hartowane bezbarwne, bez zamka |
| | 794 | 20 | 1050 | HS300 | 640,- | 10.3 | 0.037 | 1 | | drzwi szklane(2szt.)3OH z ramką aluminiowa, uniwersalne, szkło hartowane mleczne, bez zamka |
| | 160 | 110 | 20 | UC01 | 16,- | 0.2 | 0.000 | 1 | | uchwyt do szaf Svenbox Classic |
| | 300 | | | S86SI | 15,- | 0.2 | 0.002 | 1 | | wieszak wysuwny w kolorze chrom |

LEGENDA:

- WAGA NETTO

- OBJĘTOŚĆ

- ILOŚĆ PACZEK