

SVENBOX

OFFICE SOLUTIONS

cennik v.3



INVEST

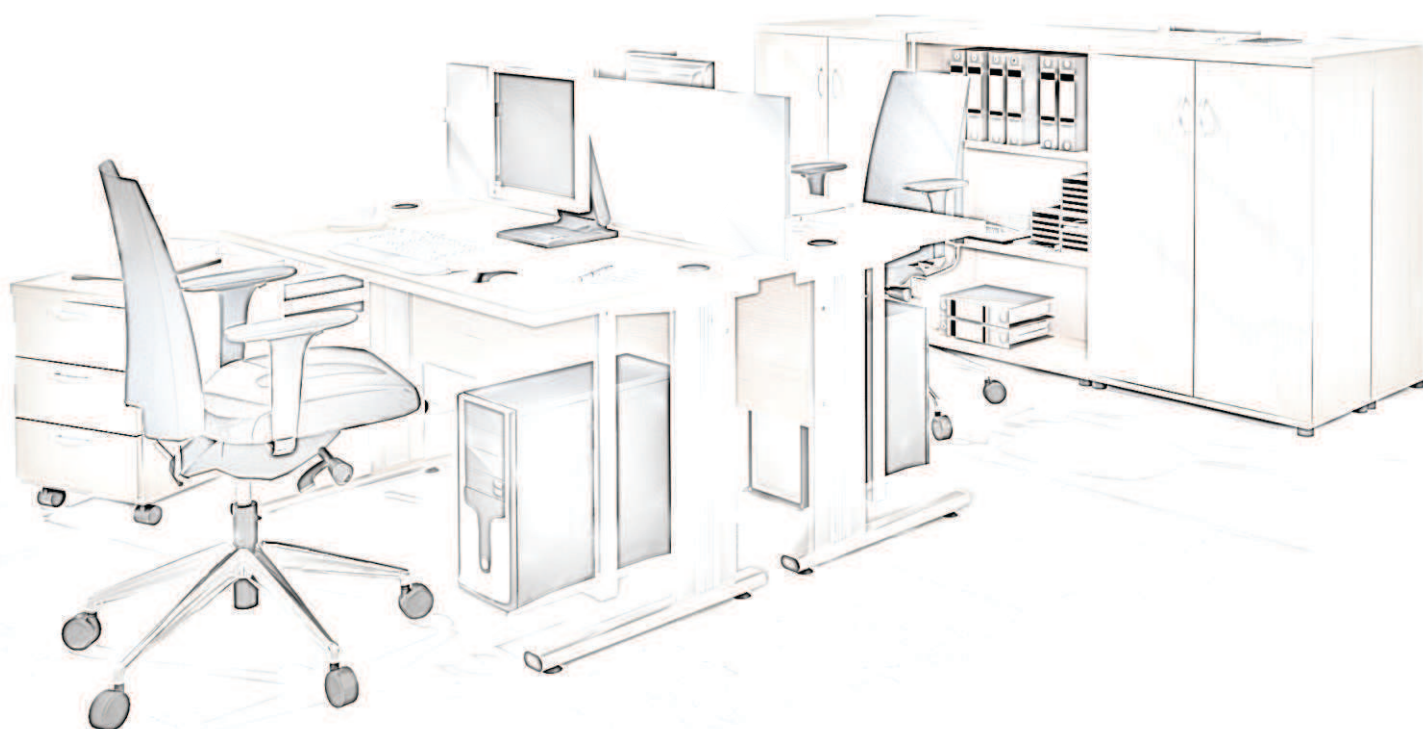



SVENBOX INVEST

ELEMENTY PŁYTOWE

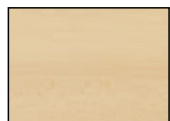

14 - BUK



78 - KLON JERSEY

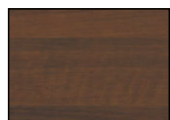

106 - ORZECH
NIZINNY

BIURKA /
PRZYSTAWKI
- blat

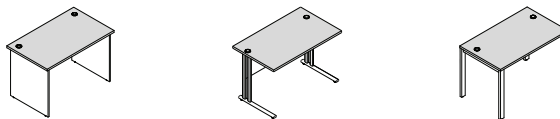

SZAFY /
KONTENERY
- front płytowy
- wieniec górny
- wieniec dolny



UKŁADY WIELOSTANOWISKOWE /
STOŁY KONFERENCYJNE /
STOLIKI
- blat

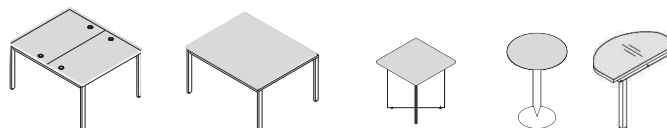

ELEMENTY PŁYTOWE



84 - POPIEL

BIURKA
- nogi płytowe
- osłony płytowe

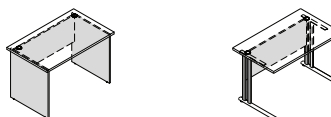

SZAFY /
KONTENERY
- korpus

SZAFKA ŻALUZJOWA
- wieniec górny
- wieniec dolny
- korpus

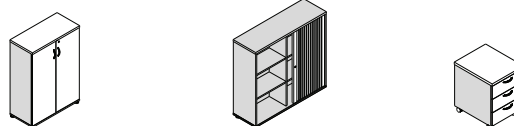

STOŁY KONFERENCYJNE /
STOLIKI
- nogi płytowe
- blenda płytowa

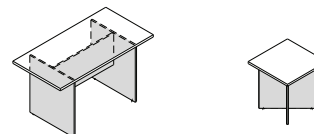

PANELE PŁYTOWE
ELEMENTY DODATKOWE

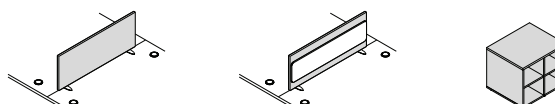

ELEMENTY METALOWE



09 - ALUMINIUM

BIURKA /
PRZYSTAWKI
- stelaż metalowy
- noga podpierająca

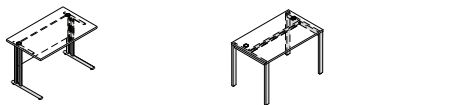

UKŁADY WIELOSTANOWISKOWE
STOŁY KONFERENCYJNE
(bez stołu PSC06)

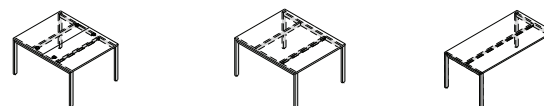

OSŁONA RASTROWA

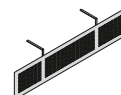

09 - ALUMINIUM



15 - BIAŁY POŁYSK

STELAŻ





▶ SVENBOX INVEST

ELEMENTY TKANINOWE



NE-3 POMARAŃCZOWY



NE-5 CZERWONY

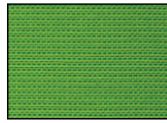

NE-9 ZIELONY



NE-10 JASNOSZARY



NE-14 CIEMNOSZARY

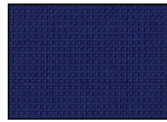

NE-15 NIEBIESKI



NE-16 CZARNY

PODUSZKA TKANINOWA

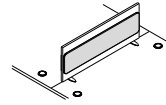

1. BIURKA

1.1 BLAT

kolor - 14 buk : płyta melaminowana 28mm, obrzeże PVC 2mm

kolor - 78 klon jersey : płyta melaminowana 25mm, obrzeże PVC 2mm

STANDARD - blat z przelotami kablowymi $\varnothing 60$

biurka proste

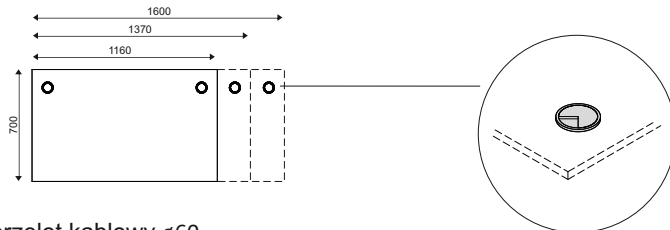

przelot kablowy $\varnothing 60$
kolor: 09 ALUMINIUM

biurka kształtowe

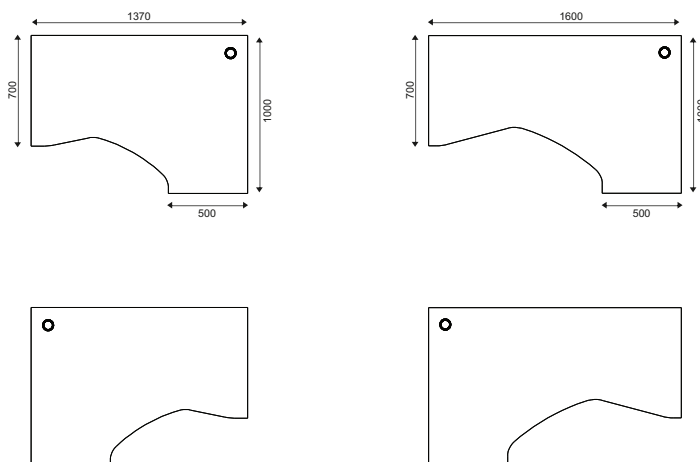

1.2 PODSTAWA

EKO_I

nogi płytowe - płyta melaminowana 18mm
blenda - płyta melaminowana 18mm

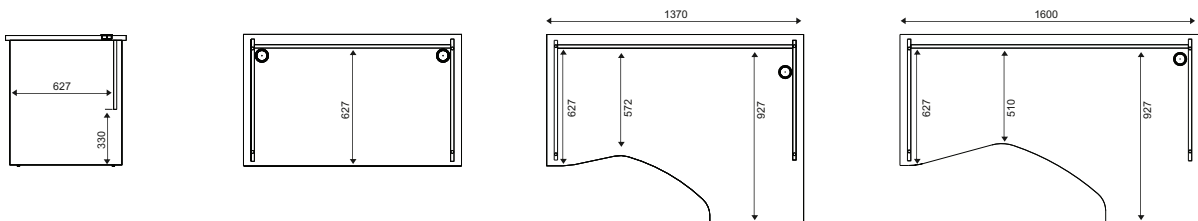
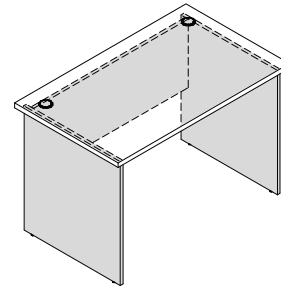

VIK_I

nogi metalowe - metal malowany proszkowo
blenda - płyta melaminowana 18mm

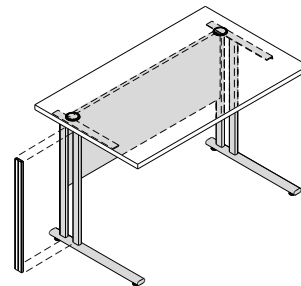

ELEMENT DODATKOWY
 kanał kablowy BM01 (2 szt.)

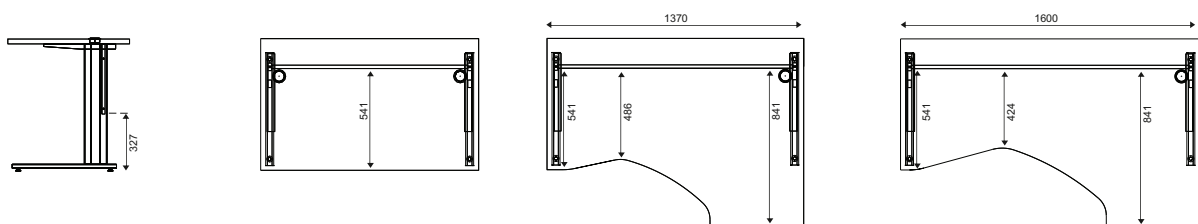

ART_I

stelaż - metal malowany proszkowo
 profil 30x60

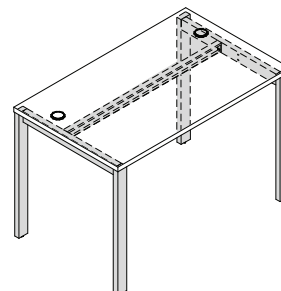

2. UKŁADY WIELOSTANOWISKOWE

2.1 BLAT

kolor - 14 buk, 106 orzech nizinny : płyta melaminowana 28mm, obrzeże PVC 2mm
 kolor - 78 klon jersey : płyta melaminowana 25mm, obrzeże PVC 2mm

STANDARD

blat z przelotami kablowymi $\varnothing 60$

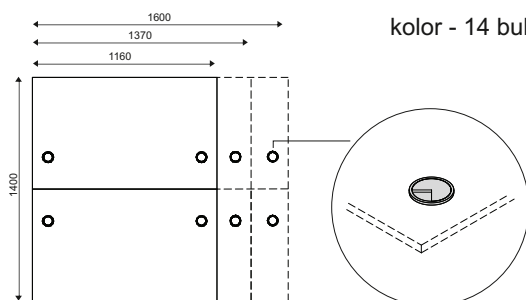

kolor - 14 buk, 106 orzech nizinny : płyta melaminowana 28mm, obrzeże PVC 2mm

2.2 STELAŻ

metal malowany proszkowo
 profil 30x60

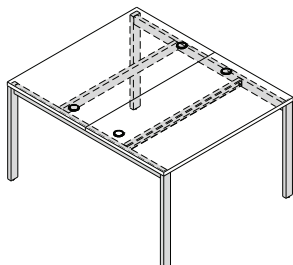

2.3 TWORZENIE UKŁADÓW WIELOSTANOWISKOWYCH

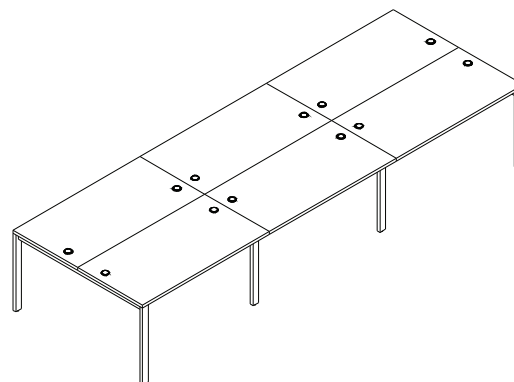
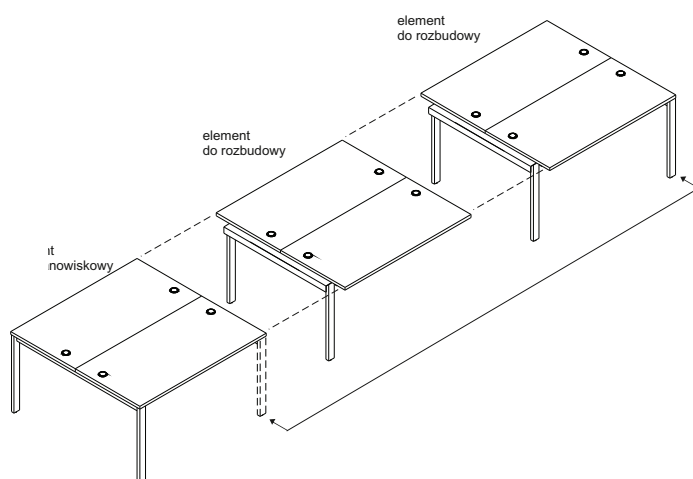

3. STOŁY KONFERENCYJNE

3.1 BLAT

kolor - 14 buk, 106 orzech nizinny : płyta melaminowana 28mm, obrzeże PVC 2mm
 kolor - 78 klon jersey : płyta melaminowana 25mm, obrzeże PVC 2mm

STANDARD

blat prosty

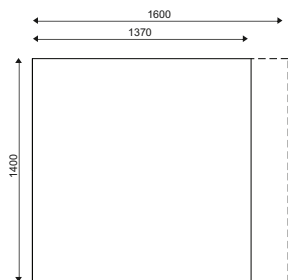

OPCJA

blat prosty TOP ACCESS M05

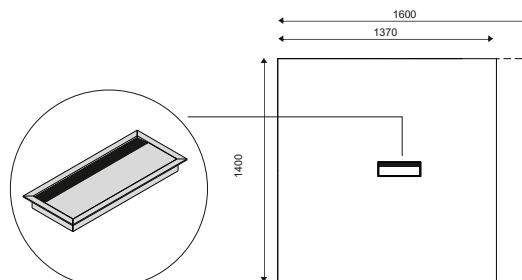

3.2 STELAŻ

metal malowany proszkowo
 profil 30x60

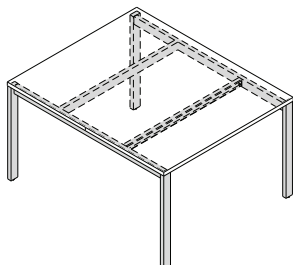

3.3 ROZBUDOWA STOŁU KONFERENCYJNEGO

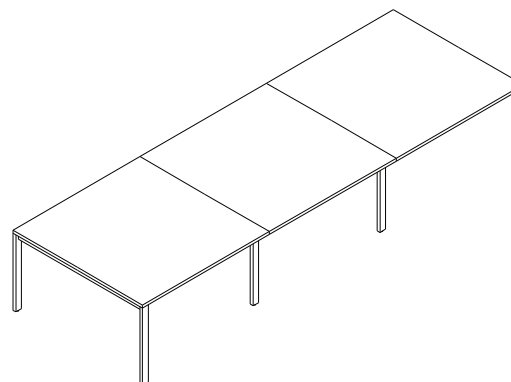
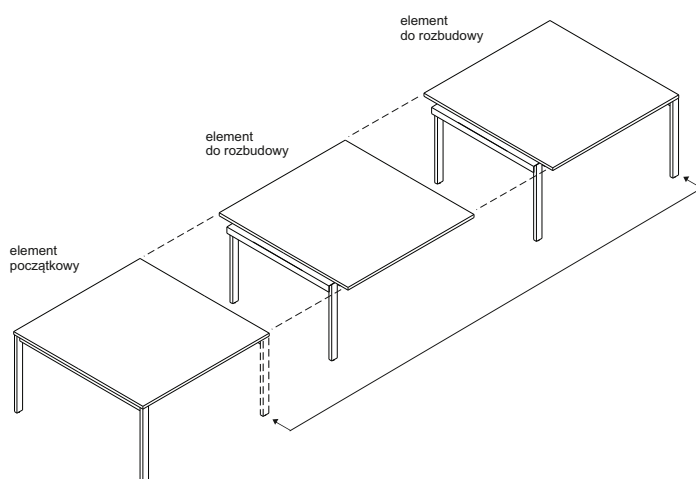

4. PANELE DO UKŁADÓW WIELOSTANOWISKORZYCH

PANELE PŁYTOWE

płyta melaminowana 18mm

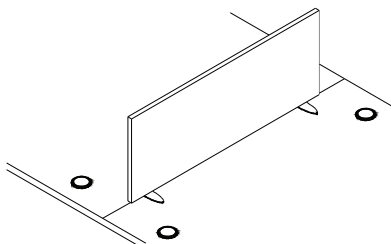

PANELE PŁYTOWE

Z PODUSZKAMI TKANINOWYMI

płyta melaminowana 18mm

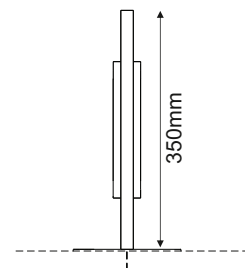
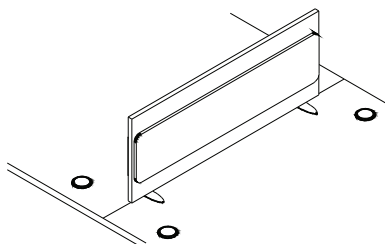

5. PRZYSTAWKI

5.1 BLAT

kolor - 14 buk, 106 orzech nizinny : płyta melaminowana 28mm, obrzeże PVC 2mm

kolor - 78 klon jersey : płyta melaminowana 25mm, obrzeże PVC 2mm

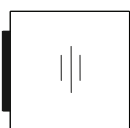
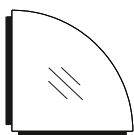

5.2 NOGA PODPIERAJĄCA

metal malowany proszkowo

 profil 40x40 mm

6. STOŁY KONFERENCYJNE

6.1 BLAT

kolor - 14 buk, 106 orzech nizinny : płyta melaminowana 28mm, obrzeże PVC 2mm
kolor - 78 klon jersey : płyta melaminowana 25mm, obrzeże PVC 2mm

6.1 STELAŻ

VPSC07 stół składany

stelaż - chrom

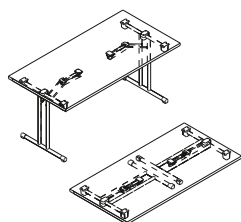
**VST08**

blat - $\varnothing 800$
talerz - stal nierdzewna, $\varnothing 500$
kolumna - metal malowany proszkowo, $\varnothing 60$

**VPH62** **VPH64**

podstawa - płyta melaminowana 18mm

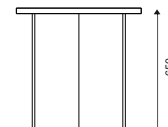
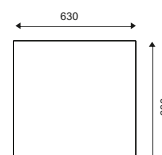
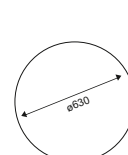
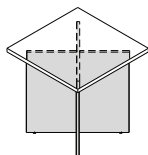
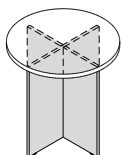
**VPH53**

podstawa - płyta melaminowana 18mm

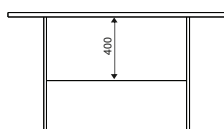
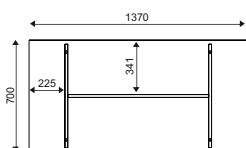
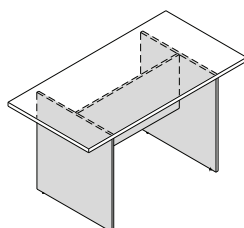
**VPH55**

stelaż - metal malowany proszkowo
profil - 30x60 mm

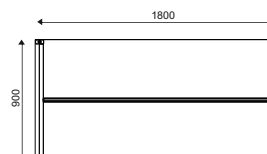
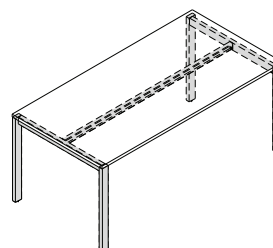

7. SZAFY I REGAŁY

7.1 WIENIEC GÓRNY

kolor - 14 buk, 106 orzech nizinny : płyta melaminowana 28mm, obrzeże PVC 2mm
 kolor - 78 klon jersey : płyta melaminowana 25mm, obrzeże PVC 2mm

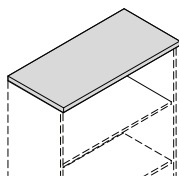

7.2 KORPUS

płyta melaminowana 18mm

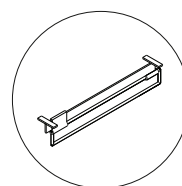
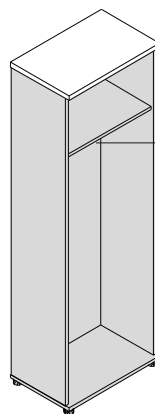
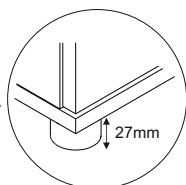
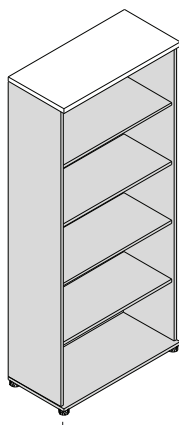

wieszak wysuwny

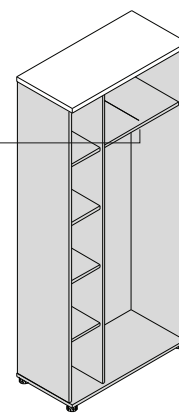

VH62
szafa ubraniowa bez zamka

Vh52
szafa ubraniowo-aktowa
bez zamka

7.3 FRONT DO SZAF I REGAŁÓW

drzwi płytowe
 - płyta melaminowana 18mm
 - zamek patentowy

drzwi szklane(2szt.) 3OH,
 - szkło hartowane bezbarwne
 - bez zamka

drzwi szklane(2szt.) 3OH
 - ramka aluminiowa
 - szkło hartowane mleczne
 - bez zamka

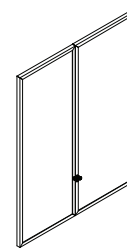
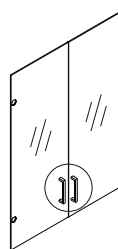
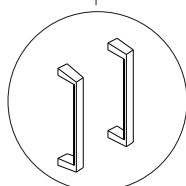
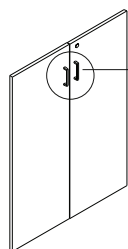

8. SZAFKA ŻALUZYJOWA

WIENIEC GÓRNY

plyta melaminowana 28mm,
obrzeże PVC 2mm

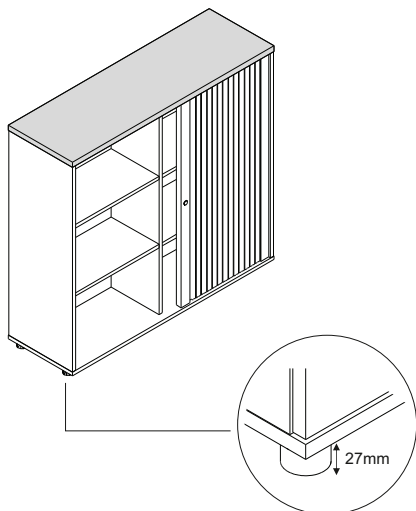
**KORPUS**

plyta melaminowana 18mm,
obrzeże PVC 2mm

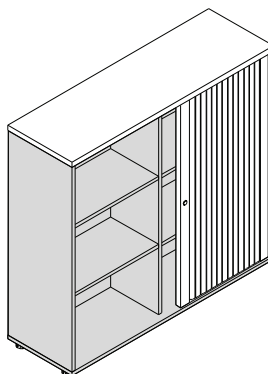
**FRONT**

żaluzja 09 - aluminium

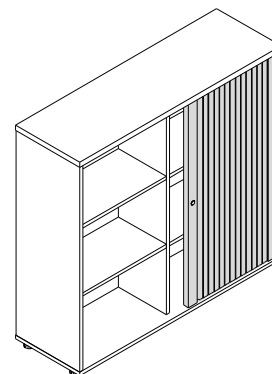

9. KONTENERY

VKH13**WIENIEC GÓRNY**

kolor - 14 buk, 106 orzech nizinny :

plyta melaminowana 28mm,
obrzeże PVC 2mm

kolor - 78 klon jersey :

plyta melaminowana 25mm,
obrzeże PVC 2mm

KORPUS

plyta melaminowana 18mm

FRONT

plyta melaminowana 18mm
zamek centralny

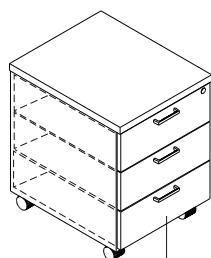
**VKH23****KORPUS**

plyta melaminowana 18mm

FRONT

plyta melaminowana 18mm
uniwersalny L/P bez zamka

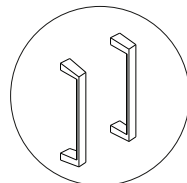
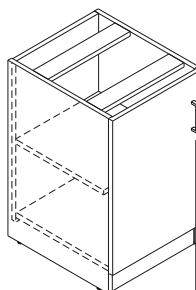

**VKH26****KORPUS**

plyta melaminowana 18mm

FRONT

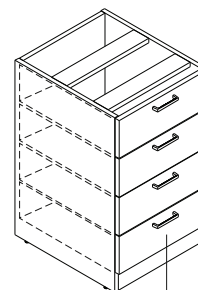
plyta melaminowana 18mm
zamek centralny



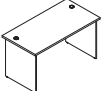
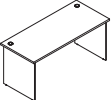

| WIDOK i RZUT OBIEKTU | WYMIARY [mm] | | | SYMBOL | CENA NETTO PLN |  |  |  | UWAGI |
|----------------------|--------------|-----------|----------|--------|----------------|---|---|---|-------|
| | SZEROKOŚĆ | GLĘBOKOŚĆ | WYSOKOŚĆ | | | kg | m3 | szt | |

BIURKA PROSTE

| | | | | | | | | | |
|---|------|-----|-----|---------------|-------|------|-------|---|--|
|  | 1160 | 700 | 758 | VBH071 | 265,- | 30.2 | 0.070 | 4 | |
|  | 1370 | 700 | 758 | VBH073 | 290,- | 34.2 | 0.078 | 4 | |
|  | 1600 | 700 | 758 | VBH076 | 310,- | 37.7 | 0.086 | 4 | |

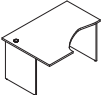
BIURKA KSZTAŁTOWE

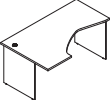
| | | | | | | | | | |
|---|------|------|-----|---------------|-------|------|-------|---|--|
|  | 1370 | 1000 | 758 | VBH025 | 415,- | 36.2 | 0.092 | 4 | |
|  | 1370 | 1000 | 758 | VBH026 | 415,- | 36.2 | 0.092 | 4 | |
|  | 1600 | 1000 | 758 | VBH047 | 450,- | 41.7 | 0.105 | 4 | |
|  | 1600 | 1000 | 758 | VBH048 | 450,- | 41.7 | 0.105 | 4 | |

LEGENDA:

 - WAGA NETTO

 - OBJĘTOŚĆ

 - ILOŚĆ PACZEK

| WIDOK i RZUT OBIEKTU | WYMIARY [mm] | | | SYMBOL | CENA NETTO PLN | | | | | UWAGI |
|----------------------|--------------|-----------|----------|--------|----------------|----|----|-----|--|-------|
| | SZEROKOŚĆ | GLĘBOKOŚĆ | WYSOKOŚĆ | | | kg | m3 | szt | | |

BIURKA PROSTE

| | | | | | | | | | | |
|--|------|-----|-----|---------------|-------|------|-------|---|--|--|
| | 1160 | 700 | 758 | VBM071 | 350,- | 27.9 | 0.075 | 3 | | |
| | 1370 | 700 | 758 | VBM073 | 385,- | 31.9 | 0.083 | 3 | | |
| | 1600 | 700 | 758 | VBM076 | 410,- | 35.4 | 0.091 | 3 | | |

BIURKA KSZTAŁTOWE

| | | | | | | | | | | |
|--|------|------|-----|---------------|-------|------|-------|---|--|--|
| | 1370 | 1000 | 758 | VBM025 | 515,- | 33.9 | 0.097 | 3 | | |
| | 1370 | 1000 | 758 | VBM026 | 515,- | 33.9 | 0.097 | 3 | | |
| | 1600 | 1000 | 758 | VBM047 | 535,- | 39.4 | 0.110 | 3 | | |
| | 1600 | 1000 | 758 | VBM048 | 535,- | 39.4 | 0.110 | 3 | | |

AKCESORIA



| | | | | | | | | | | |
|--|-----|----|----|-------------|------|-----|-------|---|--|--------------------------|
| | 682 | 50 | 30 | BM01 | 40,- | 0.5 | 0.004 | 1 | | kanal kablowy KPL (2szt) |
|--|-----|----|----|-------------|------|-----|-------|---|--|--------------------------|

LEGENDA:



- WAGA NETTO

- OBJĘTOŚĆ



- ILOŚĆ PACZEK

| WIDOK i RZUT OBIEKTU | WYMIARY [mm] | | | SYMBOL | CENA NETTO PLN |  |  |  | UWAGI |
|----------------------|--------------|-----------|----------|--------|----------------|---|---|---|-------|
| | SZEROKOŚĆ | GLĘBOKOŚĆ | WYSOKOŚĆ | | | kg | m3 | szt | |

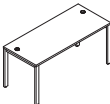

BIURKA PROSTE

| | | | | | | | | | |
|---|------|-----|-----|--------------|-------|------|-------|---|--|
|  | 1160 | 700 | 758 | VBA71 | 420,- | 32.2 | 0.077 | 3 | |
|  | 1370 | 700 | 758 | VBA73 | 440,- | 35.8 | 0.084 | 3 | |
|  | 1600 | 700 | 758 | VBA76 | 460,- | 39.8 | 0.091 | 3 | |

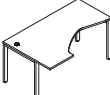
BIURKA KSZTAŁTOWE

| | | | | | | | | | |
|---|------|------|-----|--------------|-------|------|-------|---|--|
|  | 1370 | 1000 | 758 | VBA25 | 570,- | 39.5 | 0.100 | 3 | |
|  | 1370 | 1000 | 758 | VBA26 | 570,- | 39.5 | 0.100 | 3 | |
|  | 1600 | 1000 | 758 | VBA47 | 590,- | 42.7 | 0.110 | 3 | |
|  | 1600 | 1000 | 758 | VBA48 | 590,- | 42.7 | 0.110 | 4 | |

ELEMENTY DO TWORZENIA UKŁADÓW BIUREK

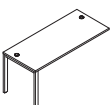

| | | | | | | | | | |
|---|------|-----|-----|--------------|-------|------|-------|---|--|
|  | 1160 | 700 | 758 | VBA12 | 370,- | 35.4 | 0.071 | 3 | |
|  | 1370 | 700 | 758 | VBA14 | 390,- | 39.0 | 0.078 | 3 | |
|  | 1600 | 700 | 758 | VBA16 | 410,- | 43.0 | 0.085 | 3 | |

LEGENDA:

 - WAGA NETTO

 - OBJĘTOŚĆ

 - ILOŚĆ PACZEK

| WIDOK i RZUT OBIEKTU | WYMIARY [mm] | | | SYMBOL | CENA NETTO PLN |  |  |  | UWAGI |
|----------------------|--------------|-----------|----------|--------|----------------|---|---|---|-------|
| | SZEROKOŚĆ | GLĘBOKOŚĆ | WYSOKOŚĆ | | | kg | m3 | szt | |

UKŁADY WIELOSTANOWISKOWE

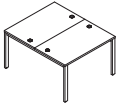
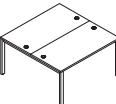
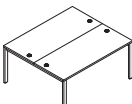
| | | | | | | | | | |
|---|------|------|-----|--------------|-------|------|-------|---|-----------------------|
|  | 1160 | 1400 | 758 | VBA21 | 840,- | 55.6 | 0.153 | 5 | układ dwustanowiskowy |
|  | 1370 | 1400 | 758 | VBA23 | 880,- | 62.8 | 0.165 | 5 | układ dwustanowiskowy |
|  | 1600 | 1400 | 758 | VBA24 | 920,- | 70.8 | 0.179 | 5 | układ dwustanowiskowy |

ELEMENTY DO TWORZENIA UKŁADÓW BIUREK

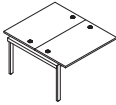
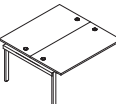
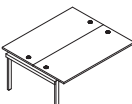

| | | | | | | | | | |
|---|------|------|-----|---------------|-------|------|-------|---|--|
|  | 1160 | 1400 | 758 | VBA211 | 735,- | 48.5 | 0.143 | 5 | |
|  | 1370 | 1400 | 758 | VBA213 | 840,- | 55.7 | 0.155 | 5 | |
|  | 1600 | 1400 | 758 | VBA214 | 880,- | 63.7 | 0.169 | 5 | |

LEGENDA:

 - WAGA NETTO

 - OBJĘTOŚĆ



 - ILOŚĆ PACZEK

| WIDOK i RZUT OBIEKTU | WYMIARY [mm] | | | SYMBOL | CENA NETTO PLN |  |  |  | UWAGI |
|----------------------|--------------|-----------|----------|--------|----------------|---|---|---|-------|
| | SZEROKOŚĆ | GLĘBOKOŚĆ | WYSOKOŚĆ | | | kg | m3 | szt | |

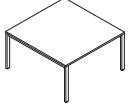
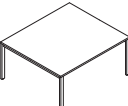
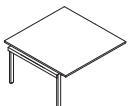
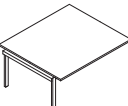
STOŁY KONFERENCYJNE

| | | | | | | | | | |
|---|------|------|-----|---------------|-------|------|-------|---|------------------------------|
|  | 1370 | 1400 | 758 | VBA123 | 860,- | 57.0 | 0.245 | 5 | |
|  | 1600 | 1400 | 758 | VBA124 | 900,- | 64.0 | 0.257 | 5 | |
|  | 1370 | 1400 | 758 | VBA113 | 820,- | 47.5 | 0.142 | 4 | element do rozbudowy układów |
|  | 1600 | 1400 | 758 | VBA114 | 860,- | 54.5 | 0.154 | 4 | element do rozbudowy układów |

DODATKOWA DOPLATA DO CECHY



| CECHA | SYMBOL | | | | |  |  |  | UWAGI |
|----------------|--------|--------|--------|--------|--|---|---|---|-------|
| | VBA123 | VBA124 | VBA113 | VBA114 | | kg | m3 | szt | |
| TOP ACCESS M05 | 150,- | 150,- | 150,- | 150,- | | 0.9 | 0.0070 | 1 | |

LEGENDA:







 - WAGA NETTO

 - OBJĘTOŚĆ

 - ILOŚĆ PACZEK

| WIDOK I RZUT OBIEKTU | WYMIARY [mm] | | | SYMBOL | CENA NETTO PLN |  |  |  | UWAGI |
|----------------------|--------------|-----------|----------|--------|----------------|---|---|---|-------|
| | SZEROKOŚĆ | GLĘBOKOŚĆ | WYSOKOŚĆ | | | kg | m3 | szt | |

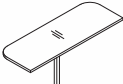
PRZYSTAWKI DO BIUREK

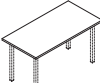
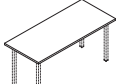
| | | | | | | | | | |
|---|------|------|-----|--------------|-------|------|-------|---|--|
|  | 700 | 700 | 28 | VPH77 | 140,- | 12.5 | 0.018 | 1 | |
|  | 500 | 500 | 28 | VTH10 | 65,- | 5.3 | 0.011 | 1 | |
|  | 500 | 700 | 28 | VTH09 | 75,- | 7.3 | 0.015 | 1 | |
|  | 500 | 900 | 28 | VTH11 | 90,- | 8.5 | 0.018 | 1 | |
|  | 500 | 1400 | 758 | VPH71 | 230,- | 14.0 | 0.043 | 2 | |
|  | 400 | 700 | 758 | VPH72 | 150,- | 7.7 | 0.029 | 2 | |
|  | 700 | 700 | 28 | VTH12 | 80,- | 9.0 | 0.019 | 1 | w cenę nie wliczono nóg podpierających (4szt.) |
|  | 1370 | 700 | 28 | VTH15 | 130,- | 17.2 | 0.038 | 1 | w cenę nie wliczono nóg podpierających (4szt.) |
|  | 1600 | 700 | 28 | VTH14 | 140,- | 22.0 | 0.041 | 1 | w cenę nie wliczono nóg podpierających (4szt.) |

NOGI PODPIERAJĄCE

| | | | | | | | | | |
|---|----|----|-----|-------------|------|-----|-------|---|-----------------|
|  | 40 | 40 | 730 | NH44 | 65,- | 2.0 | 0.017 | 1 | noga kwadratowa |
|---|----|----|-----|-------------|------|-----|-------|---|-----------------|

OSŁONY PRZEDNIE DO BIUREK - RASTROWE

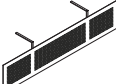
| | | | | | | | | | |
|---|------|----|-----|--------------|-------|-----|-------|---|--|
|  | 1400 | 15 | 300 | CUR15 | 286,- | 3.1 | 0.009 | 1 | |
|---|------|----|-----|--------------|-------|-----|-------|---|--|

LEGENDA:

 - WAGA NETTO

 - OBJĘTOŚĆ

 - ILOŚĆ PACZEK



| WIDOK i RZUT OBIEKTU | WYMIARY [mm] | | | SYMBOL | CENA NETTO PLN | | | | | UWAGI |
|----------------------|--------------|-----------|----------|--------|----------------|----|----|-----|--|-------|
| | SZEROKOŚĆ | GLĘBOKOŚĆ | WYSOKOŚĆ | | | kg | m3 | szt | | |

PANELE PŁYTOWE

| | | | | | | | | | | |
|--|------|----|-----|-------|-------|-----|-------|---|--|--|
| | 650 | 18 | 350 | RH070 | 110,- | 3.0 | 0.016 | 1 | | |
| | 900 | 18 | 350 | RH090 | 145,- | 4.0 | 0.022 | 1 | | |
| | 1300 | 18 | 350 | RH130 | 165,- | 6.8 | 0.041 | 1 | | |

PANELE PŁYTOWE Z PODUSZKAMI TKANINOWYMI













| | | | | | | | | | | |
|--|------|----|-----|--------|-------|------|-------|---|--|--|
| | 650 | 45 | 350 | RH070P | 350,- | 9.0 | 0.016 | 1 | | |
| | 900 | 45 | 350 | RH090P | 390,- | 12.0 | 0.022 | 1 | | |
| | 1300 | 45 | 350 | RH130P | 435,- | 17.0 | 0.032 | 1 | | |

LEGENDA:

- WAGA NETTO

- OBJĘTOŚĆ

- ILOŚĆ PACZEK

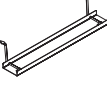

| WIDOK i RZUT OBIEKTU | WYMIARY [mm] | | | SYMBOL | CENA NETTO PLN |  |  |  | UWAGI |
|---|--------------|-----------|----------|--------------|----------------|---|---|---|--|
| | SZEROKOŚĆ | GLĘBOKOŚĆ | WYSOKOŚĆ | | | kg | m3 | szt | |
|  | 140 | 70 | 750 | S81SI | 125,- | 1.1 | 0.008 | 1 | |
|  | 1000 | 70 | 35 | S82SI | 65,- | 1.0 | 0.005 | 1 | |
|  | 212 | 460 | 617 | S83SI | 130,- | 2.7 | 0.027 | 1 | kolor: 09 - aluminium |
|  | | | | AK3SI | 30,- | 0.2 | 0.000 | 1 | |
|  | 470 | 220 | 148 | S73SI | 140,- | 3.2 | 0.002 | 1 | kolor: 84 - popiel |
|  | 470 | 256 | 146 | CH11 | 80,- | 2.5 | 0.012 | 1 | kolor: 84 - popiel |
|  | 362 | 167 | 23 | CH21 | 30,- | 0.5 | 0.003 | 1 | piórnik nakładany, czarny |
|  | 610 | 400 | 85 | C01SI | 125,- | 0.5 | 0.010 | 1 | półka pod klawiaturę - tworzywo szare |
|  | 560 | 372 | 110 | CH01 | 80,- | 4.9 | 0.028 | 1 | półka pod klawiaturę, kolor: 84 - popiel |
|  | 580 | 162 | 123 | S69SI | 75,- | 1.0 | 0.015 | 1 | kolor: 09 - aluminium |
|  | 460 | 110 | 121 | E64SI | 65,- | 0.0 | 0.000 | 0 | |

LEGENDA:





 - WAGA NETTO

 - OBJĘTOŚĆ

 - ILOŚĆ PACZEK

| WIDOK i RZUT OBIEKTU | WYMIARY [mm] | | | SYMBOL | CENA NETTO PLN |  |  |  | UWAGI |
|----------------------|--------------|-----------|----------|--------|----------------|---|---|---|-------|
| | SZEROKOŚĆ | GLĘBOKOŚĆ | WYSOKOŚĆ | | | kg | m3 | szt | |

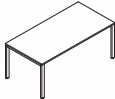
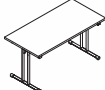
STOŁY I STOLIKI

| | | | | | | | | | |
|---|------|-----|-----|---------------|-------|------|-------|---|--|
|  | 630 | 630 | 650 | VPH62 | 235,- | 15.0 | 0.035 | 1 | |
|  | 630 | 630 | 650 | VPH64 | 225,- | 17.0 | 0.037 | 1 | |
|  | 1370 | 700 | 758 | VPH53 | 300,- | 31.6 | 0.073 | 1 | |
|  | 1800 | 900 | 758 | VPH55 | 610,- | 48.0 | 0.108 | 3 | |
|  | 1390 | 695 | 725 | VPSC07 | 620,- | 23.0 | 0.112 | 2 | stół składany - stelaż w kolorze chrom |
|  | 800 | 800 | 730 | VST08 | 830,- | 21.0 | 0.218 | 2 | |

LEGENDA:

 - WAGA NETTO

 - OBJĘTOŚĆ

 - ILOŚĆ PACZEK



| WIDOK i RZUT OBIEKTU | WYMIARY [mm] | | | SYMBOL | CENA NETTO PLN | | | | UWAGI |
|----------------------|--------------|-----------|----------|--------|----------------|----|----------------|-----|-------|
| | SZEROKOŚĆ | GLĘBOKOŚĆ | WYSOKOŚĆ | | | kg | m ³ | szt | |

SZAFY I REGAŁY

| | | | | | | | | | |
|--|-----|-----|------|------|-------|------|-------|---|------------------------------------|
| | 802 | 385 | 2185 | VH61 | 650,- | 68.0 | 0.154 | 3 | |
| | 602 | 385 | 1833 | VH62 | 430,- | 40.0 | 0.151 | 3 | - szafa ubraniowa bez zamka |
| | 602 | 385 | 1833 | VH65 | 310,- | 33.0 | 0.110 | 2 | |
| | 802 | 802 | 1833 | VH05 | 650,- | 68.0 | 0.229 | 2 | |
| | 802 | 385 | 1833 | VH51 | 515,- | 57.8 | 0.138 | 3 | |
| | 802 | 385 | 1833 | VH52 | 610,- | 55.5 | 0.141 | 3 | - szafa ubraniow-aktowa, bez zamka |
| | 802 | 385 | 1833 | VH54 | 440,- | 47.7 | 0.117 | 3 | |
| | 802 | 385 | 1833 | VH55 | 350,- | 40.0 | 0.100 | 2 | |
| | 802 | 385 | 1129 | VH31 | 400,- | 35.0 | 0.084 | 3 | |
| | 802 | 385 | 1129 | VH34 | 360,- | 32.7 | 0.075 | 3 | |
| | 802 | 385 | 1129 | VH35 | 250,- | 25.0 | 0.059 | 2 | |

LEGENDA:

- WAGA NETTO

- OBJĘTOŚĆ

- ILOŚĆ PACZEK



| WIDOK i RZUT OBIEKTU | WYMIARY [mm] | | | SYMBOL | CENA NETTO PLN | | | | | UWAGI |
|----------------------|--------------|-----------|----------|--------|----------------|----|----|-----|--|-------|
| | SZEROKOŚĆ | GLĘBOKOŚĆ | WYSOKOŚĆ | | | kg | m3 | szt | | |

SZAFY UNIWERSALNE

| | | | | | | | | | | |
|--|-----|-----|-----|------|-------|------|-------|---|--|--|
| | 802 | 385 | 777 | VH11 | 340,- | 26.7 | 0.066 | 3 | | do zastosowania jako nadstawka, dostawka do biuła lub szafa wolnostojąca |
| | 802 | 385 | 777 | VH12 | 220,- | 19.0 | 0.049 | 2 | | do zastosowania jako nadstawka, dostawka do biuła lub szafa wolnostojąca |
| | 602 | 385 | 777 | VH10 | 205,- | 17.0 | 0.040 | 2 | | do zastosowania jako nadstawka, dostawka do biuła lub szafa wolnostojąca |

SZAFĄ ŻALUZYJOWA

| | | | | | | | | | | |
|--|------|-----|------|--------|---------|------|-------|---|--|---------------------------|
| | 1200 | 385 | 1129 | SK3Z06 | 1 250,- | 64.0 | 0.600 | 1 | | cała w kolorze 84- popiel |
|--|------|-----|------|--------|---------|------|-------|---|--|---------------------------|

ELEMENTY DODATKOWE

| | | | | | | | | | | |
|--|-----|-----|-----|-------|-------|------|-------|---|--|--|
| | 710 | 600 | 600 | S85SI | 290,- | 32.0 | 0.066 | 1 | | szafka pod ksero, cała w kolorze 84-popiel |
| | 350 | 385 | 370 | SH351 | 120,- | 6.0 | 0.016 | 1 | | organizer - cały w kolorze 84-popiel |

KONTENERY

| | | | | | | | | | | |
|--|-----|-----|-----|-------|-------|------|-------|---|--|--|
| | 435 | 525 | 590 | VKH13 | 390,- | 26.2 | 0.139 | 1 | | |
| | 428 | 495 | 730 | VKH23 | 240,- | 19.3 | 0.044 | 1 | | |
| | 428 | 495 | 730 | VKH26 | 440,- | 25.5 | 0.180 | 1 | | |

LEGENDA:

- WAGA NETTO

- OBJĘTOŚĆ

- ILOŚĆ PACZEK



| WIDOK i RZUT OBIEKTU | WYMIARY [mm] | | | SYMBOL | CENA NETTO PLN | | | | | UWAGI |
|----------------------|--------------|-----------|----------|--------|----------------|----|----|-----|--|-------|
| | SZEROKOŚĆ | GLĘBOKOŚĆ | WYSOKOŚĆ | | | kg | m3 | szt | | |

ELEMENTY DODATKOWE DO SZAF

| | | | | | | | | | | |
|--|-----|----|------|--------------|-------|------|-------|---|--|---|
| | 796 | 18 | 1754 | VH51D | 185,- | 16.5 | 0.042 | 1 | | |
| | 596 | 18 | 1754 | VH62D | 130,- | 14.3 | 0.059 | 1 | | drzwi uniwersalne(lewe i prawe) bez zamka |
| | 796 | 18 | 1050 | VH31D | 160,- | 11.8 | 0.025 | 1 | | |
| | 796 | 18 | 699 | VH11D | 130,- | 6.9 | 0.020 | 1 | | |
| | 596 | 18 | 699 | VH10D | 105,- | 5.0 | 0.026 | 1 | | drzwi uniwersalne(lewe i prawe) bez zamka |
| | 796 | 5 | 1050 | VHS23 | 240,- | 11.0 | 0.040 | 1 | | drzwi szklane(2szt.)3OH, szkło hartowane bezbarwne, bez zamka |
| | 794 | 20 | 1050 | HS300 | 640,- | 10.3 | 0.037 | 1 | | drzwi szklane(2szt.)3OH z ramka aluminiowa, uniwersalne, szkło hartowane mleczne, bez zamka |
| | 300 | | | S86SI | 15,- | 0.2 | 0.002 | 1 | | wieszak wysuwny w kolorze chrom |

LEGENDA:

- WAGA NETTO

- OBJĘTOŚĆ

- ILOŚĆ PACZEK